

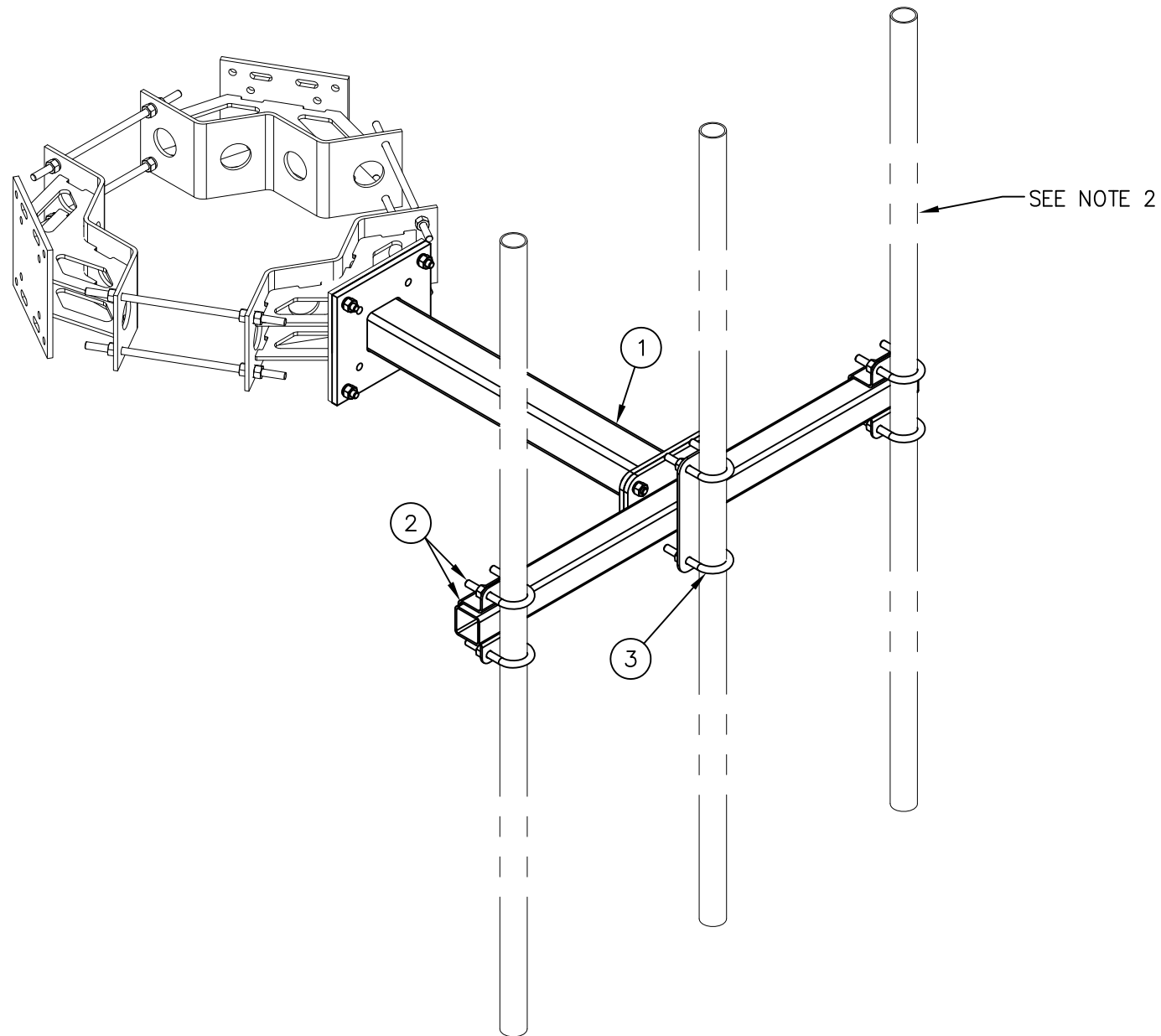

C10113451 T-ARM ASSEMBLY

ITEM	QTY.	PART NO.	DESCRIPTION	WEIGHT
1.	1	C10113401	KIT, 4'-6" T-ARM	110
2.	2	C40207001	KIT, PIPE MOUNT (CLAMP + 2 U-BOLTS)	12
3.	2	C40034023	U-BOLT ASSEMBLY, 5/8 ϕ X 3 1/16 C-C	3
TOTAL WEIGHT				125



ISOMETRIC VIEW

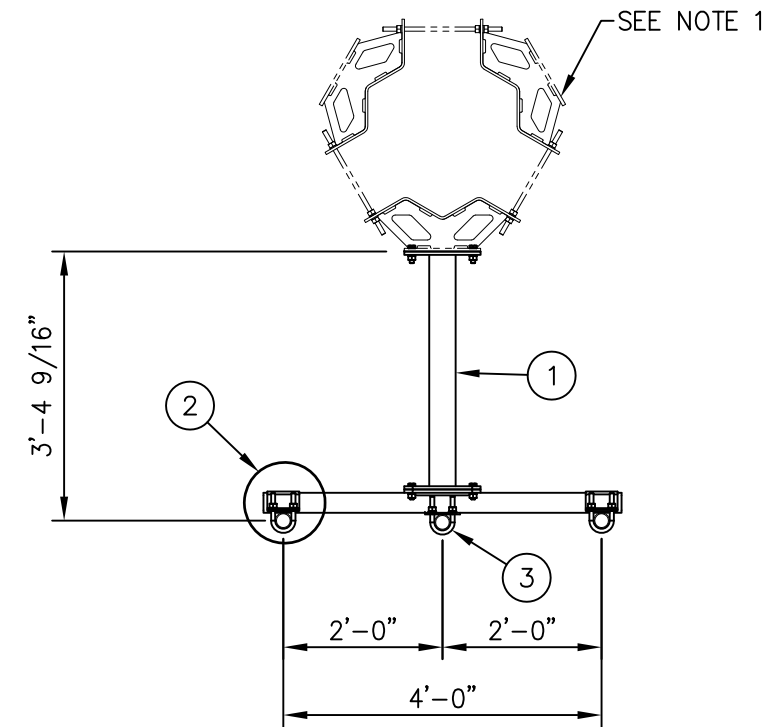

PLAN VIEW

NOTES:

1. TRI-COLLAR MOUNTS ARE SHOWN TYPICAL AND MUST BE PURCHASED SEPARATELY.
2. 2 3/8" O.D. MOUNTING PIPE MUST BE PURCHASED SEPARATELY.
3. QUANTITIES SHOWN IN LIST OF MATERIAL ARE FOR ONE (1) T-ARM ASSEMBLY ONLY.

UNLESS OTHERWISE SPECIFIED
ALL DIMENSIONS INCLUDE
FINISHES AND ARE IN INCHES
TOLERANCES: FRACTIONS $\pm 1/16"$
ANGLES $\pm 1/2$ DEG.
DECIMALS $\pm .010"$

MATERIAL:
TOLERANCES DO NOT APPLY
TO RAW MATERIAL



CONFIDENTIAL
This document and the information
contained herein is the confidential trade
secret property of Sabre Communications
Corporation ("Sabre") and must not be
reproduced, copied or used, in whole or in
part, for any purpose without the prior
written consent of Sabre.
© 2014 Sabre Communications Corporation.
All rights reserved.

T-ARM ASSEMBLY
3'-0" ARM WITH 4'-6" FACE
W/ANTENNA MOUNTING PIPE HARDWARE
NO ANTENNA MOUNTING PIPES

REV	DATE	DRW/CHK	DESCRIPTION

DATE	6/4/09	SIZE	B	DRAWING NO.	C10113451	REV	0
DRAWN BY	MLC	SCALE	None	PAGE	1	OF	1
CHECKED BY	MC						



C10112300 TRI-COLLAR ASSEMBLY (10"-40" MONOPOLE)

ITEM	QTY.	PART. NO.	DESCRIPTION	WEIGHT
1.	3	CW00835	WELDMENT, TRI-COLLAR (10"-40" MONOPOLE)	151
2.	6	C40094012	THREADED ROD ASSEMBLY 5/8 X 2'-9"	25
3.	6	C40094002	THREADED ROD ASSEMBLY 5/8 X 1'-6"	17
TOTAL WEIGHT				193

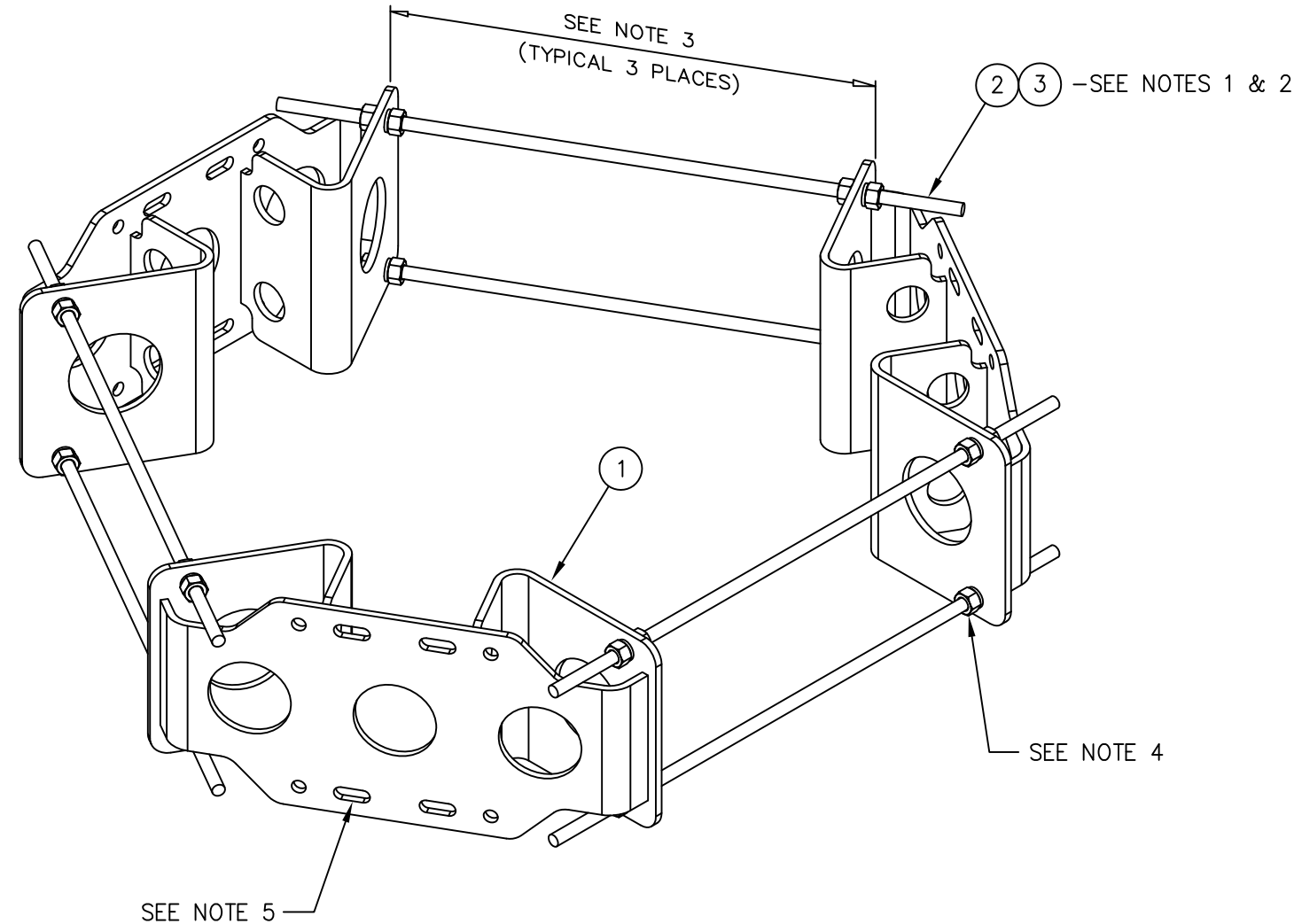

ISOMETRIC VIEW

NOTES:

1. THERE ARE (2) LENGTHS OF THREADED ROD SUPPLIED TO ACCOMMODATE DIAMETERS LISTED BELOW
 USE 5/8 X 1'-6" THREADED ROD ASSEMBLY FOR 10"-24" MONOPOLE DIAMETERS
 USE 5/8 X 2'-9" THREADED ROD ASSEMBLY FOR 24"-40" MONOPOLE DIAMETERS (SEE NOTE 2)
2. THREADED ROD MAY BE SHORTENED IF REQUIRED, FIELD CUT AND COLD GALV SPRAY TO SUIT.
3. THIS DISTANCE MUST BE EQUAL IN ALL (3) THREE LOCATIONS TO ENSURE THE STRUCTURAL INTEGRITY OF THE THREADED RODS AS WELL AS 120° SEPARATION.
4. FOR MONOPOLES 13" DIA. OR SMALLER, ONLY (1) ONE NUT AND (1) ONE LOCKWASHER ARE REQUIRED BETWEEN THE TRI-COLLAR BRACKETS.
 FOR MONOPOLES LARGER THAN 13" DIA., (2) TWO NUTS AND (2) TWO LOCKWASHERS ARE REQUIRED BETWEEN THE TRI-COLLAR BRACKETS.
5. THE MOUNTING SLOTS NOTED WILL ACCOMMODATE 2 3/8"-4 1/2" O.D. MOUNTING PIPES.

UNLESS OTHERWISE SPECIFIED
 ALL DIMENSIONS INCLUDE
 FINISHES AND ARE IN INCHES
 TOLERANCES: FRACTIONS ± 1/16"
 ANGLES ± 1/2 DEG.
 DECIMALS ± .010"

MATERIAL:
 TOLERANCES DO NOT APPLY
 TO RAW MATERIAL



TRI-COLLAR BRACKET ASSEMBLY
 FOR MONOPOLES (10"-40" DIA.)
 (CIRCUMFERENCE 31.4" TO 125.7")

REV	DATE	DRW	CHK	DESCRIPTION
2	8/11/10	DLW	DEL	ADDED 5/8 X 1'-6" THREADED ROD
1	1/6/10	MLC	MC	REDRAWN IN AUTOCAD

CONFIDENTIAL
 This document and the information contained herein is the confidential trade secret property of Sabre Communications Corporation ("Sabre") and must not be reproduced, copied or used, in whole or in part, for any purpose without the prior written consent of Sabre.
 © 2014 Sabre Communications Corporation. All rights reserved.

DATE	8/21/09	SIZE	B	DRAWING NO.	C10112300	REV	2
DRAWN BY	JV	CHECKED BY	MLC	SCALE	None	PAGE	1 OF 1